

COMPANY PROFILE

Ningbo Yiyi Network Technology Group Co., Ltd., as the overseas service center of Zhejiang Shiteng Technology Group Co., Ltd., is a digital supply chain service supplier, founded in 2009 and headquartered in Ningbo.

Shiteng group is mainly engaged in the research and development, design, production, sales, construction and operation and maintenance of intelligent traffic security, landscape lighting, garden sanitation, municipal pipeline network, pumps, valves and fittings, factory warehousing, heating, cooling and ventilation, artificial turf, suspended flooring, and construction machinery, providing one-stop solutions and services.

Currently, we cooperate with more than 5,000 manufacturing enterprises and serve nearly 200,000 enterprise customers. With 15 supply chain companies, over 80 sales subsidiaries and product companies, more than 1,000 people in the service team, our digital management capabilities and comprehensive service capabilities are at the forefront of the industry.



Ningbo Yiyi Network Technology Group Co., Ltd.

 www.yiyitraffic.com

 industrial@nbstkg.com

 No.77 of Building 10, No.818 Qiming Road, Yinzhou District, Ningbo 315000, Zhejiang, China

|| Flood control barrier

- 01 Aluminum Flood Barriers
- 03 ABS Flood Barriers
- 04 Telescopic Water Barrier
- 05 Flood Control Embankment

|| Road Traffic

- 06 Wave Guardrail
- 06 City Road Guardrail
- 06 Lawn Guardrail
- 07 Bridge Guardrail
- 07 Revolving Barrel Guardrail
- 08 Crash Pad
- 08 Luminous Barrier
- 10 Movable Guardrail
- 10 Fence
- 10 Acoustic Barrier
- 11 Metal Bellows
- 11 Road Traffic Signs
- 11 Moving Signal Lamp

|| Crash Barrier

- 12 Zinc Steel Fence
- 12 Cast Iron Fence
- 12 Foundation Pit Net

|| Wire Fence

- 13 Slope Protection Net
- 13 Double Side Wire Fence
- 13 Frame Fence
- 14 Bilateral Wire Fence
- 14 Stadium Fence
- 14 Airport Prison Fence
- 15 Holland Wire Mesh
- 15 Workshop Isolation Network
- 15 Mobile Protective Net

|| Smart Lamp

- 16 Solar Energy Lamp Series
- 16 LED Spotlight
- 17 LED Tree Hugger Lights
- 17 LED Buried Lights
- 18 LED Wall Washer
- 18 LED Outline Light
- 19 LED Underwater Light
- 19 LED Wall Lamp
- 20 LED Lawn Lamp
- 20 LED Court Light

Flood control barrier

Aluminum Alloy Flood Barriers

1 Thickened column - concave and convex design, close connection.



2 Warning label - black and yellow reflective, eye-catching tips.



3 Column-integrated seamless casting.

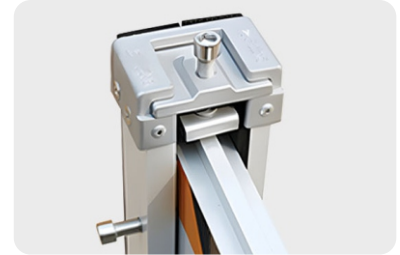

4 Width-can be customized Height-Can be over lied.



5 Installation accessories All stain-less steel



6 Thickened waterproof rubber strip - tight waterproof.



Flood Barrier Mounting Options for Door

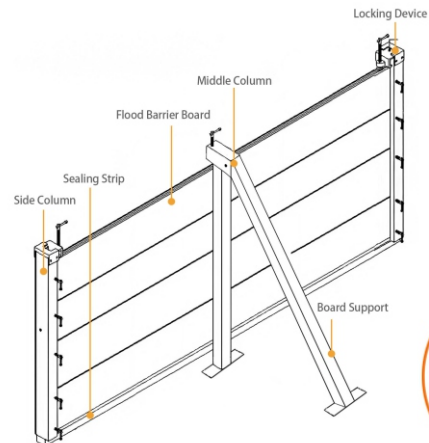
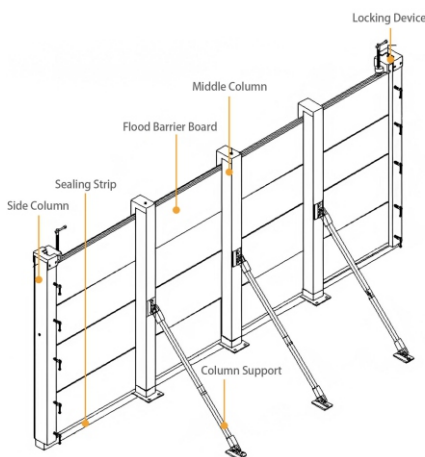
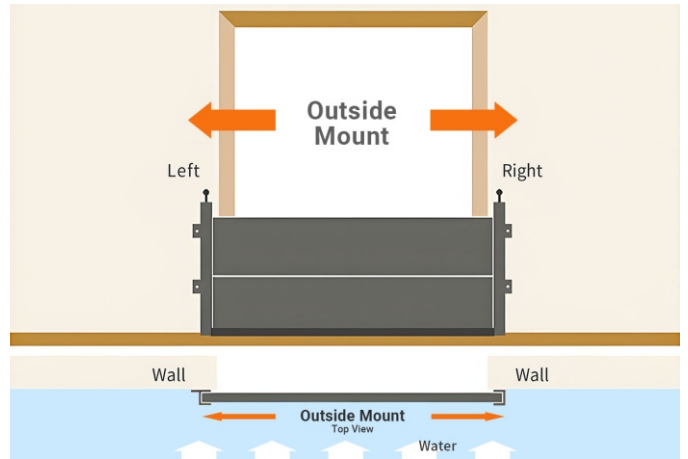
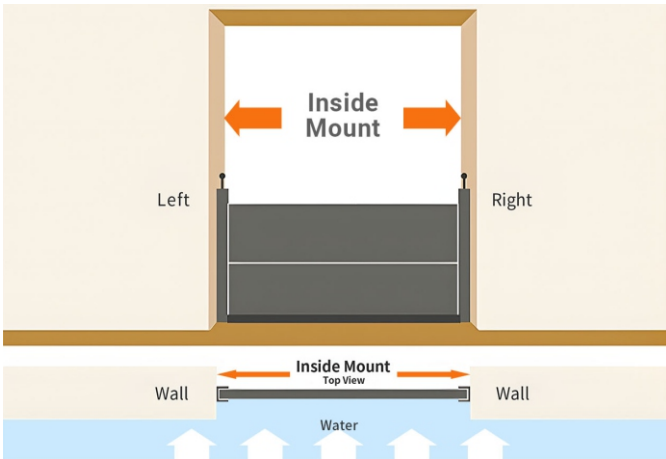

Flood control barrier

Aluminum Alloy Flood Barriers

Installation of Real Scenes



Flood Barrier Mounting Options for Bank



Flood control barrier

ABS Flood Barriers

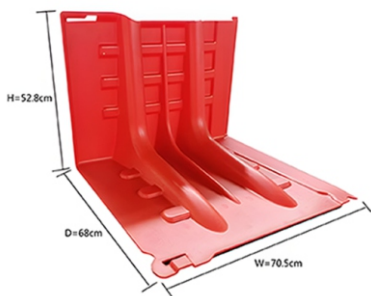

YWZ50

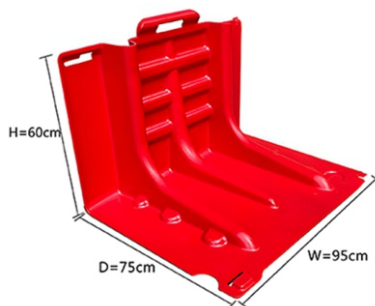

YWZ60

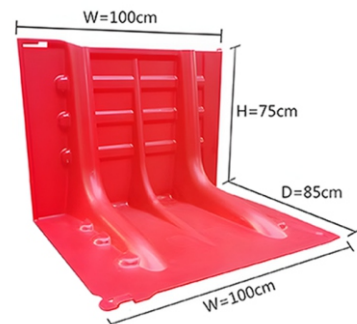

YWZ75

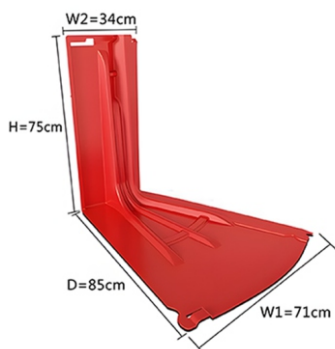

YWW75

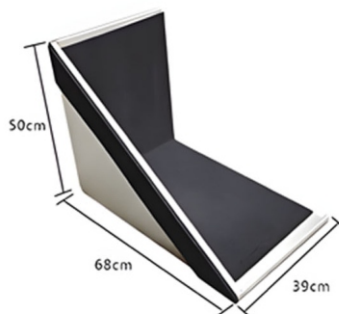

50cm High
Stainless Steel Edge Sealing Plate

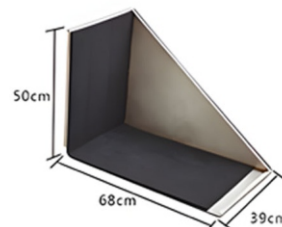

Warehouse Entrance



Garage Entrance



Water Channel



Power Facilities

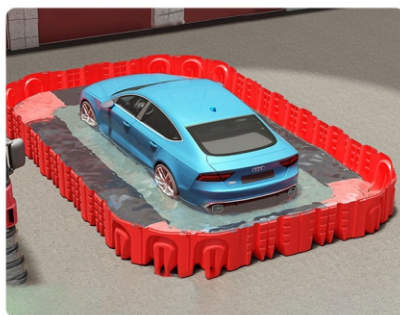

Combination Form



Supermarket Entrance

Flood control barrier

Telescopic Combined Water Barrier



Product Advantages

- > Lightweight, easy and quick to install
- > Convenient to disassemble, store, and transport
- > Reusable, durable, and environmentally friendly
- > Flexible combinations to adapt to flat or uneven surfaces



Flood Control Height	90cm
Telescopic Width	15cm - 130cm
Weight	5.6kg
Main Material 1	High-strength carbon steel pipe
Main Material 2	Polyvinyl chloride waterproof Oxford cloth
Tensile Strength	629MPa
Yield Strength	611MPa



Flood control barrier

Flood Control Embankment



Road Traffic

Double Wave Guardrail



Specification : (Length *Width*Wave height*Thickness)
Length 4320mm, width 310mm, wave height 85mm,
plate thickness: 3mm, 4mm.
Material: Q235

Three Wave Guardrail



Specification : (length * width * wave height * thickness)
Length 4320mm, width 506mm, wave height 85mm,
plate thickness: 4mm
Material: Q235

City Road Guardrail

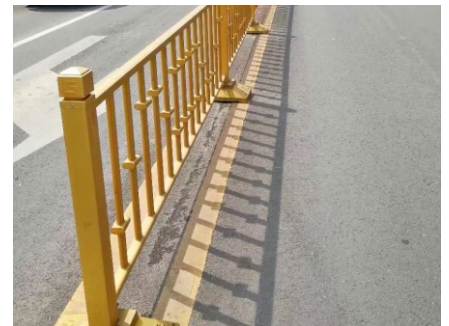

City guardrail is beautiful and novel, easy to install, safe and reliable, with favorable price. The isolation of city traffic arteries, highway intermediate green isolation zones, bridges, secondary roads, township roads and various highway toll gates.

Road Traffic

Lawn Guardrail



PVC lawn guardrail, cement lawn guardrail. Decorate the courtyard green space, garden paths, city avenue, white bright visual effect.

Bridge Guardrail



Bridge guardrail refers to the guardrail set on the bridge. Its purpose is to prevent out-of-control vehicles out of the bridge rail, so that vehicles can not break through, under the bridge, over the bridge as well as beautify the function of the bridge building.

Revolving Barrel Guardrail



Under the premise of ensuring the anti-collision performance, the guiding performance and buffering performance of the rotating guardrail have obvious advantages over the traditional guardrail products.

Crash Pad



After the vehicle crashes into the anti-collision pad, the momentum of the vehicle is successively transmitted to the anti-collision cylinder, so that the speed of the vehicle and the anti-collision cylinder is successively reduced, and then the speed of the vehicle is reduced to less than 15km/h.

Luminous Barrier



Photoenergy safety column

Size:With light option:114mm*860mm

Without light option:114mm*790mm

Product material: Cold-rolled steel plate + natural rubber

Color options: black-yellow, yellow-white, and green-white available

Column light types: steady light, strobe light

Luminous Barrier



LB-802-1



LB-802-2



LB-802-3



LB-802-4



LB-802-5



LB-802-6

LED Stone Ball

Optional specifications and sizes

Circle diameter: 500mm

Circle diameter: 400mm

Weight: approximately 160KG

Weight: approximately 90KG

LB-802 Illuminated anti-collision pillar

Customizable company name and logo at the base

Luminous Barrier

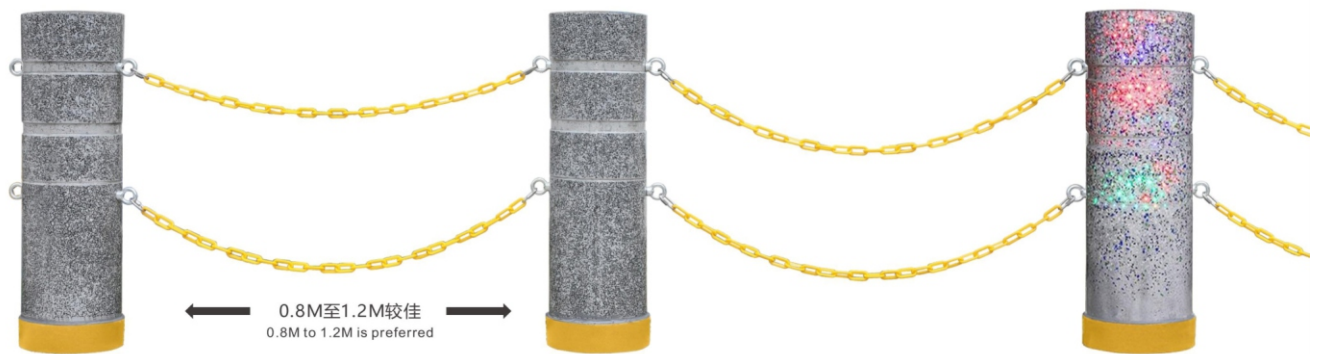

LB-601 illuminated anti-collision pillar

Circle diameter :230mm

Weight:approximately 65KG

Weight:approximately 35KG

Circle diameter :170mm

Optional specifications and sizes

Road Traffic

Movable Guardrail



Is set in the central median opening, for the convenience of special vehicles (such as traffic accident vehicles, emergency vehicles) in an emergency to pass and one side of the road construction closed when the temporary opening of the release of the activities of the facility.

Fence



The enclosure is a kind of facility that isolates the construction site from the external environment and makes the construction site a relatively closed and isolated space.

Acoustic Barrier



When sound barriers are set up on an elevated highway or overpass, the shadow area of the sound barrier can be increased due to the use of the height of the highway and the overpass itself to improve the effective height of the sound barrier.

Road Traffic

Metal Bellows



Refers to lay buried in the highway, railroad below the culvert with threaded corrugated pipe, it is made of corrugated metal plate rolled or made of semicircular corrugated steel sheet assembled into a circular corrugated pipe, is widely used in highways, railroads, small bridges, passages, retaining walls and a variety of mines, tunnel retaining wall support and other construction sites.

Road Traffic Signs



Moving Signal Lamp



Solar red circle, yellow circle, green circle on the same screen display red arrows, yellow arrows, green arrows on the same screen display moving lights.

Crash Barrier

Zinc Steel Fence

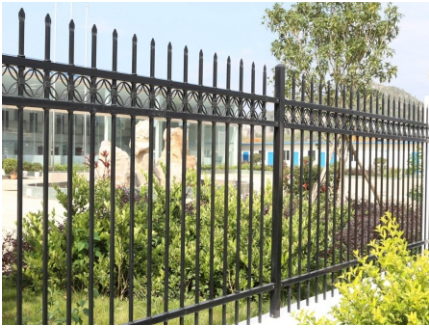

Made of zinc alloy material, it has the advantages of high strength, high hardness, beautiful appearance, bright color and so on.

Cast Iron Fence



1. Cast iron as a material.
2. Unique modeling, product quality and low price, cost-effective.
3. High usage rate, easy to moisture, need to pay attention to moisture.

Foundation Pit Net



Mainly made of welded connections, can be used in the pit edge and other various engineering construction temporary protection.

Wire Fence

Slope Protection Net



In order to limit the slope rock and soil weathering spalling or damage and collapse of dangerous rocks (reinforcement), or to control the falling rocks in a certain range of movement (enclosure), to protect the pedestrians and vehicles through the safety.

Double Side Wire Fence



Bilateral wire fence mesh has simple structure, less material, low processing cost, easy to transport remotely, so the project cost is low.

Frame Fence



It can be made into a permanent wall, but also can be used as a temporary isolation netting, only need to use different post fixing method can be realized.

Wire Fence

Bilateral Wire Fence



Mesh Diameter : 3.5~8mm
Mesh : 7.5*15cm
Mesh Height: 1.8m~2.5m
Length : 3m,
Post Size: Commonly Used 5cm*7cm, 7cm*10cm
Thickness: 1mm

Stadium Fence



The most important feature of the product is the flexibility of strong, according to the requirements of the structure of the mesh can be adjusted at any time, modeling and size.

Airport Prison Fence



It is composed of V-shaped support column reinforced welded sheet net, security anti-theft connector and hot-dip galvanized blade barbed cage, with high strength and safety defensive level. It is now widely used in high-security places such as prisons and military bases.

Wire Fence

Holland Wire Mesh

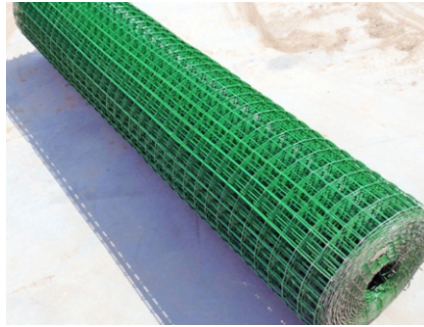

A piece of Dutch mesh should be welded by the same type of steel bar. Welded wire mesh is divided into two types according to the shape and specification: fixed type and customized type.

Workshop Isolation Network



Isolation mesh is also known as fence mesh, fence, warehouse workshop isolation mesh is also called mesh partition;

Mobile Protective Net

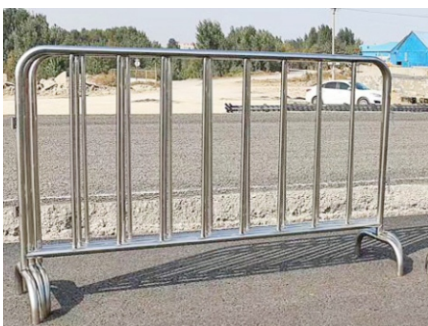

Mobile fence also known as temporary fence mobile fence . Mobile Fence 1.Mesh Welded Mobile Fence 2.Steel Pipe Welded Mobile Fence

Smart Lamp

Solar Energy Lamp Series



TYN-01001



TYN-00804
H:6-10m



TYN-02203
H:6-8m

LED Spotlight



Enclosure Material:
High-quality aluminum die casting
Size: Small 150/ Medium 190/ Large 250mm
Lamp Power: 24W/48W/72W



Enclosure Material:
High-quality aluminum die casting
Size: 100*96*103mm
Lamp Power: 6*2W



Enclosure Material:
High-quality aluminum die casting
Size: 200*200mm
Lamp Power: 36W

Smart Lamp

LED Tree Hugger Lights



Enclosure Material:
High-quality aluminum die casting
Size:60mm/80mm/100mm
Lamp Power:10W/20W/30W



Enclosure Material:
High-quality aluminum die casting
Size:130mm/145mm
Lamp Power:9W/12W/18W



Enclosure Material:
High-quality aluminum die casting
Size:Outer diameter 400mm
Inner diameter 270mm
Lamp Power:72W/18W*4 series

LED Buried Lights



Enclosure Material:
High-quality aluminum die casting
Size:150mm/190mm/250mm
Lamp Power:9.2W/18*2W/24*2w



Enclosure Material:
High-quality aluminum die casting
Size:210mm/235mm/270mm/310mm
Lamp Power:18*2W/24*2W/36*2W/60*2W



Enclosure Material:
High-quality aluminum die casting
Size:100*90*1000*65mm
Lamp Power:12W/18W/24W/36W

Smart Lamp

LED Wall Washer



Enclosure Material:
High-quality aluminum die casting
Size:36*36*1000mm/42*28*1000mm
Lamp Power:18W/24W/36W



Enclosure Material:
High-quality aluminum die casting
(Dual-row light source)
Size:65*30*1000mm
Lamp Power:48W/72W

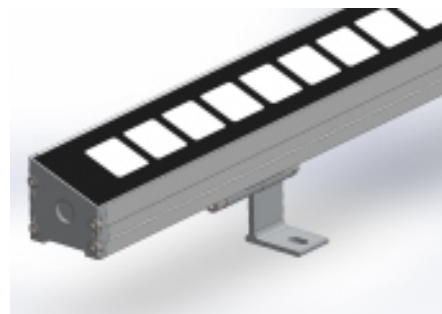

Enclosure Material:
High-quality aluminum die casting
Size:39*38*1000mm
Lamp Power:24W/18W

LED Outline Light



Enclosure Material:
Aluminum alloy base+Dual-layer PC cover
Size:30*47*1000mm
Lamp Power:12W/15W



Enclosure Material:
High-quality aluminum alloy
transparent glass
Size:28*26*1000mm
Lamp Power:12W/15W



Enclosure Material:
Thickened aluminum alloy
transparent PC cover
Size:50*42*1000mm
Lamp Power:12W/15W

Smart Lamp

LED Underwater Light



Enclosure Material:
Standard underwater light/stainless steel
Size: Φ 120/145/180/200mm
Lamp Power: 6W/12W/18W/24W



Enclosure Material:
High-quality aluminum die casting
Size: Φ 90mm
Lamp Power: 12W/15W



Enclosure Material:
High-quality aluminum die casting
Size: Φ 42/52/62mm
Lamp Power: 1W/3W/6W(3)

LED Wall Lamp



Enclosure Material:
High-quality aluminum die casting
Size: 90mm/110mm/145mm
Lamp Power: 6W/24W/36W



Enclosure Material:
High-quality aluminum die casting
Size: 90mm/110mm/145mm
Lamp Power: 12W/15W



Enclosure Material:
High-quality aluminum die casting
Size: 65*65mm
Lamp Power: 12W/15W

Smart Lamp

LED Lawn Lamp



Enclosure Material:
High-quality aluminum die casting
Size:110*110*600mm
Lamp Power:15W



Enclosure Material:
High-quality aluminum die casting
Size:150mm/Φ180mm h600mm
Lamp Power:12w/15w



Enclosure Material:
High-quality aluminum die casting
Size:65*65mm
Lamp Power:15W

LED Court Light



Enclosure Material:
High-quality aluminum die casting
Size:340*236*220mm
Lamp Power:100W/200W/300W



Enclosure Material:
High-quality aluminum die casting
Size:36 *36 *32mm
Lamp Power:300W/400W/600W



Enclosure Material:
High-quality aluminum die casting
Size:650*260*95mm
Lamp Power:90W/100W